

Article number: 2310431003S

Description: E+G Levelling elements
LX.25-SW13-M6X36-S

Measures

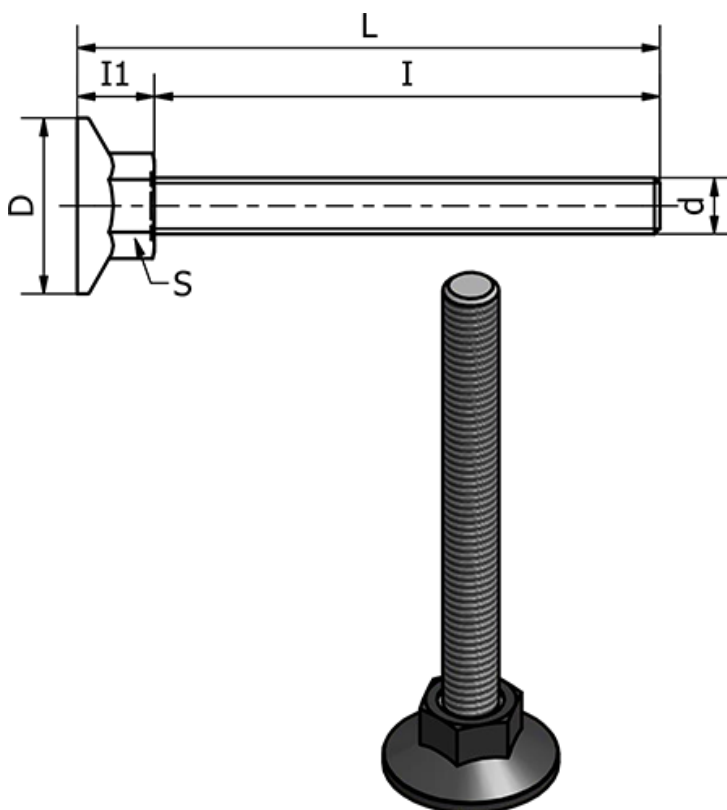

d	= M6
D	= 25
I	= 36
I1	= 11
L	= 47
S	= 13
Static load in (N)	= 1500
Type	= Forzinket

Weight (g) = -